

Laag model
1900 - 2200

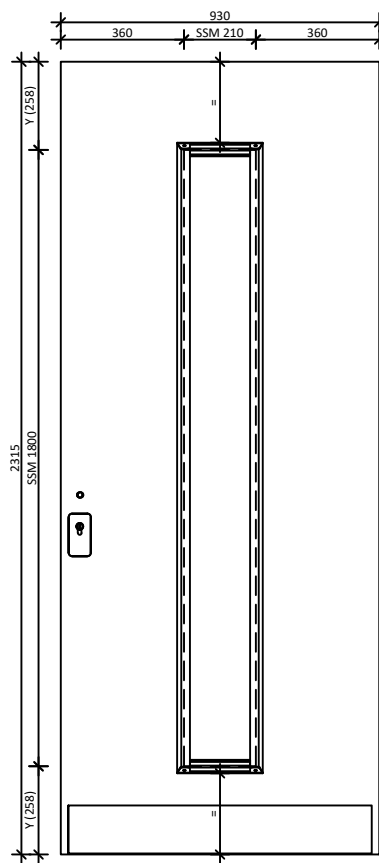

Midden model
2201 - 2400

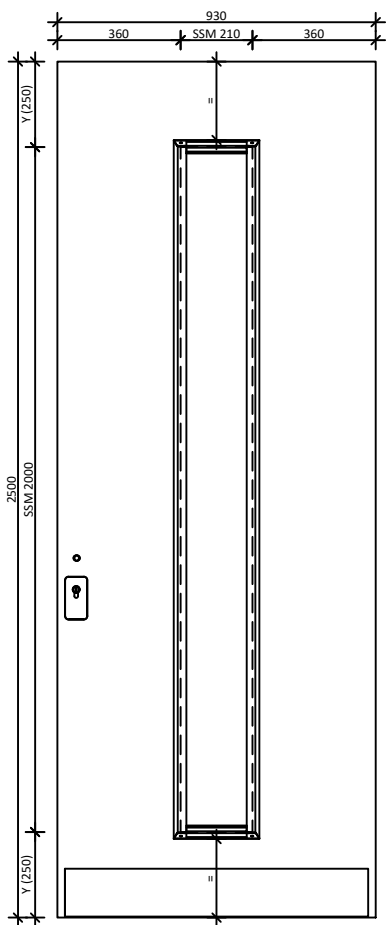

Hoog model
2401 - 2600

Kruk gat alleen aan binnenzijde, ivm combi rozet (cilinder en deurknop) als standaard

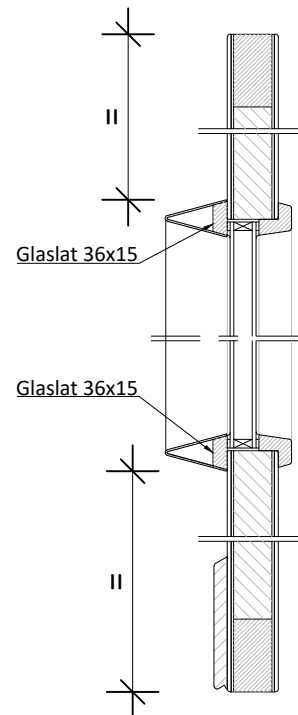
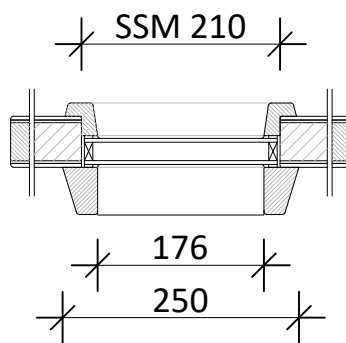

DATUM:
01-02-2024

GEWIJZIGD:

CALCULATIENR:

TEKENINGNR:
20230201-941-01

MODEL:
94111

HOUTSOORT:

KEGRO | DEUREN

KLANT/PROJECT:
Model 94111 Overzicht

DCM NUMMER:

AANVRAAG:

SCHAAL:

GETEKEND:
KF

LEVERWEEK: